

UNO-2271G V2

Pocket-Size Edge IoT Gateway with Intel® Celeron® N6210/ Pentium® N6415



Features

- Intel® Celeron® Dual core N6210/ Pentium® Quad core N6415 processor with 4GB/8GB DDR4 onboard memory
- Pocket-size, robust, fanless and cable-free system with high stability
- Optional second stack for increasing functionality including POE, COM, wireless connectivity or iDoor expansion
- Support Win11, Ubuntu Classic and Ubuntu Core 20
- Microsoft Azure IoT Edge and Amazon AWS IoT Greengrass certified

Introduction

Advantech's UNO-2000 series of embedded automation computers are highly rugged, fanless systems. The modular design offers strong computing performance and flexible scalability with various I/O ports for IoT Connectivity. The UNO-2271G V2 are designed as IoT edge gateways. Their pocket size design features versatile I/O ports and expansion options to support wire/wireless communication, and AI accelerators for IoT edge data analysis and processing. UNO-2271G V2 IoT edge gateways enable various industrial applications across multiple industries.

Specifications

General

- **Certification** CE, FCC, UL, CCC, BSMI
- **Dimensions (W x D x H)** 100 x 70 x 40 mm/3.9 x 2.8 x 1.57 in
- **Form Factor** Pocket sized
- **Enclosure** Aluminum
- **Mount Options** Stand, wall, VESA (optional), DIN rail (optional)
- **Weight (Net)** 0.5 kg/1.1 lb
- **Power Requirement** 10 ~ 30V_{DC}
- **Power Consumption** 12W (typical), 30W (max.)
- **Operating System** Windows10 LTSC, Windows 11, Ubuntu 20.04, Ubuntu Core 20
- **Software Compatibility** WISE-Edge365, Azure IoT Edge, AWS IoT Greengrass

System Hardware

- **BIOS** AMI UEFI x64
- **Watchdog Timer** Programmable interval timer, from 1 to 255 seconds
- **Processor** Intel® Celeron® N6210 dual-core (1.2 GHz)/ Pentium® N6415 quad-core (1.2 GHz)
- **Memory** 4 GB/8 GB DDR4 3200 MHz onboard
- **Graphics Engine** Intel® UHD Graphics
- **Ethernet** 2 x i210AT
- **LED Indicators** Power, Run (programmable), LAN (active, status)
- **Storage** 32/64GB eMMC (up to 256 GB upon request)
1 x mSATA slot shared with mPCIe slot
- **Expansion** 1 x Full-size mPCIe slot (SATA/PCIe/USB2.0 signal)
- **Hardware Security** TPM2.0 (TPM2.0 Library Reversion 1.38)

I/O Interfaces

- **LAN Ports** 2 x RJ45, 10/100/1000 Mbps IEEE 802.3u
1000BASE-T Fast Ethernet
- **USB Ports** 2 x USB 3.2 Gen 1
- **Display Output** 1 x HDMI (1920 x 1080 @60Hz)
- **Power Connector** 1 x 2-pin terminal block

Environment

- **Operating Temperature** -20 ~ 60 °C (-4 ~ 140 °F) with 0.7m/s airflow
- **Storage Temperature** -40 ~ 85 °C / -40 ~ 185 °F
- **Relative Humidity** Operating, 95% RH @ 40° C, Non-Condensing
Non-Operating, 95% RH @ 60° C, Non-Condensing
- **Shock Protection** Operating, IEC 60068-2-27, 50G, half sine, 11 ms
- **Vibration Protection** Operating, IEC 60068-2-64, 2 Grms, random,
5 ~ 500 Hz, 1hr/axis (mSATA)
- **Ingress Protection** IP30

Installation Scenarios

Stand/Wall Mount

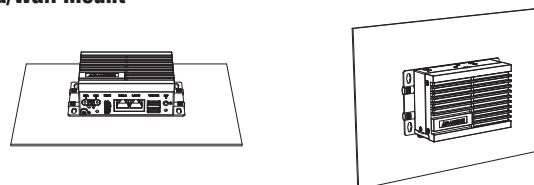

DIN-Rail Mount (optional)

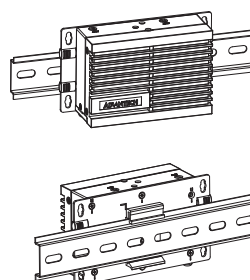

VESA Mount (optional)

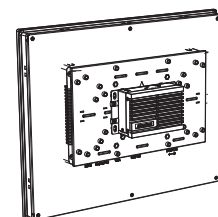

Dimensions

Unit: mm

Single stack

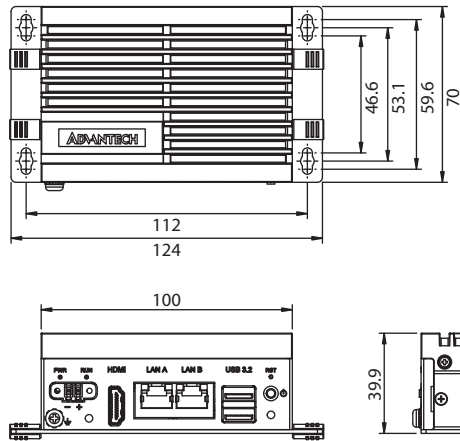

Double stack

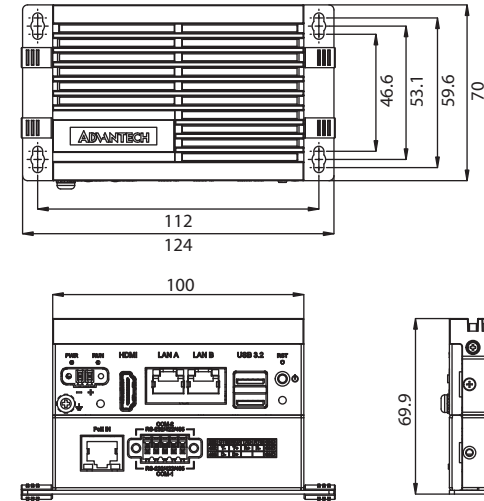

Front I/O

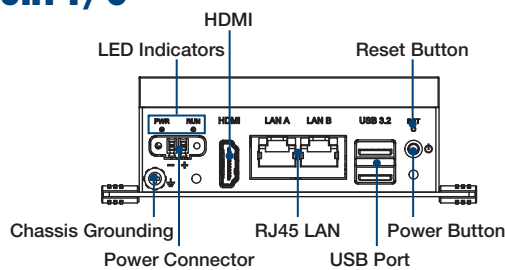

Rear I/O

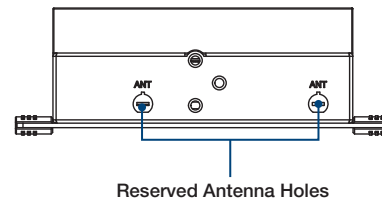

Ordering Information

Part Number	CPU	Cores	RAM	Storage	Remark
UNO-2271G-N221BE	Intel® Celeron® N6210	2	4GB	32GB eMMC	
UNO-2271G-N221BU	Intel® Celeron® N6210	2	4GB	32GB eMMC	US region
UNO-2271G-N231BE	Intel® Pentium® N6415	4	8GB	64GB eMMC	
UNO-2271G-N231BU	Intel® Pentium® N6415	4	8GB	64GB eMMC	US region

Embedded OS

- 20704WX9ES0000 WIN10 IoT Enterprise 2019 x64 LTSC v6.07 B005
- 20704WX1ES0001 WIN10 IoT Enterprise 2021 x64 LTSC v6.08 B009
- 20704U20CS0000 Ubuntu Core 20 - Intel IOTG version_20211213
- 20704U20DS0000 Ubuntu Desktop - Intel IOTG version_20211203
- 20704U20DS0001 AdvLinuxTu V3.0.4 for UNO series

Optional Accessories

Adapters and Power Cables

- PWR-247-DE 60W AC to DC UNO series power adapter
- 1702002600 Power cable (US) 1.8 M
- 1702002605 Power cable (EU) 1.8 M
- 1702031801 Power cable (UK) 1.8 M
- 1700000596 Power cable (China/Australia) 1.8 M

Mount Kits

- UNO-2271G-DMKAE UNO-2271G DIN-rail mount kit
- UNO-2000G-VMKCE UNO-2000 VESA mount kit

Miscellaneous

- UNO-2000-LKAE Cable lock kit, 10 units per pack

Wi-Fi Module (mPCIe) and Antenna

- EWM-W193H01E Realtek mPCIe module with Wi-Fi 802.11 a/b/g/n/ac, 2T2R, and BT4.2
- 9656EWMG00E Half to full-size mPCIe bracket
- 1750008799-01 Cable Ant.SMA/F-R-BH MFH4/113 BLK L170
- 1750008717-01 Antenna, 10.9 cm, 50 Ohm

LTE Module (mPCIe) and Antenna

- 968AD00589 Quectel EG25G LTE Cat. 4 mPCIe module with SIM slot (CE RED certified)
- 1750008303-01 Antenna AN0727-64SP6BSM
- 1750006264 Antenna SMA(F)/MHF, 15 cm

Stackable Extension Kits

UNO-2271G-EKCE

Second stack module for iDoor technology



Front I/O

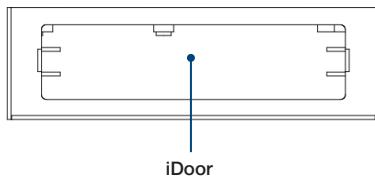

Specifications

General	
I/O	1 x iDoor slot (chassis only)
Dimensions	100 x 70 x 30 mm/ 3.93 x 2.75 x 1.18 in
Weight	100 g/0.22 lb
Environment	
Operating Temperature	Dependent on iDoor module installed

Ordering Information

Part Number	Description
UNO-2271G-EKCE	UNO-2271G V2 2nd stack extension kit for iDoor

Optional iDoor Modules*

Part Number	Description
PCM-24D2R2-BE	2-port isolated RS-232 mPCIe, DB9
PCM-24D2R4-BE	2-port isolated RS-422/485 mPCIe, DB9
PCM-24D4R2-BE	4-port non-isolated RS-232 mPCIe, DB37
PCM-24D4R4-BE	4-port non-isolated RS-422/485 mPCIe, DB37
PCM-2300MR-BE	MR4A16B, 2 MB MRAM, mPCIe
PCM-26D2CA-BE	2-port isolated CAN bus mPCIe, CANopen, DB9
PCM-27D24DI-AE	24-channel isolated digital I/O with counter mPCIe, DB37
PCM-24R2GL-AE	2-port Gigabit Ethernet, mPCIe, RJ45
PCM-23U1DG-CE	USB slot with lock for USB dongle

*Contact Advantech for more compatible iDoor solutions.

UNO-2271G-RP1EA

Second stack module with 2 x COM, 1 x PoE (PD), 1 x M.2 (B key)

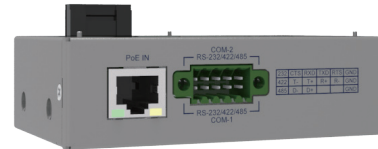

Front I/O

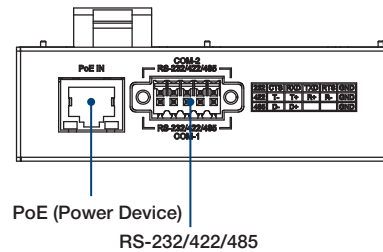

Specifications

General	
I/O	2 x COM (RS-232/422/485) terminal block 1 x PoE+ (802.3at) (power device) Note: Because PoE can only provide 25.5W max. power, USB ports should only be used to connect USB 2.0 devices.
Expansion	1 x M.2 (B key) (SATA/USB 3.0 signals for LTE)
SIM Slot	1 x nano SIM slot
Dimensions	100 x 70 x 30 mm/ 3.93 x 2.75 x 1.18 in
Weight	120 g/0.26 lb
Environment	
Operating Temperature	-20 ~ 60 °C/-4 ~ 140 °F

Ordering Information

Part Number	Description
UNO-2271G-RP1EA	UNO-2271G V2 second stack module with 2 x COM, 1 x PoE, 1 x M.2 (B key)

UNO-2271G-RS2EA

Second stack module with 2 x COM, 1 x M.2 (B key), 1 x M.2 (E key)

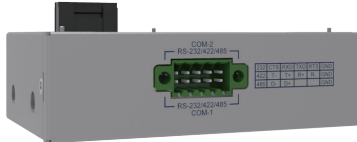

Front I/O

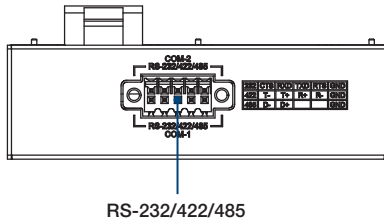

Specifications

General	
I/O	2 x COM (RS-232/422/485) terminal block
Expansion	1 x M.2 (B key) (SATA/USB 3.0 signals for LTE) 1 x M.2 (E key) (PCIe/USB 2.0 signals for Wi-Fi)
Network Connectivity	1 x nano SIM slot
Dimensions	100 x 70 x 30 mm/ 3.93 x 2.75 x 1.18 in
Weight	120 g/0.26 lb
Environment	
Operating Temperature	-20 - 60 °C/-4 - 140 °F

Ordering Information

Part Number	Description
UNO-2271G-RS2EA	UNO-2271G V2 second stack module with 2 x COM, 2 x M.2 (B+E key)

Optional Accessories

Wi-Fi Connectivity Kit (M.2 A-E key)

Part Number	Description
AIW-166K3	Intel Wi-Fi 6+BT 5.3 Module 2.4/5/6GHz M.2 2230 noVpro
1750008799-01	SMA cable, 170mm
1751000342-01	Antenna
EXM-CMPF1-M2E01E	mPCIe to E key converter card

LTE Module (mPCIe) and Antenna

Part Number	Description
968AD00589	Quectel EG25-G LTE Cat. 4 mPCIe module (EMEA/APAC)
1750006264	SMA cable, 150 mm
1750008303-01	Antenna

AT&T/Verizon-Certified LTE Kit for North America

Part Number	Description
C-PCM-24S24G-227-2	LTE kit with MultiTech LTE Cat. 4 modem, M.2 (B key) 3042 adapter board, 2 x SMA cables and antennas